

Free Wings to Fly Forward



E-MAGAZINE OF GRADE VI
INDIAN SCHOOL AL BURAIMI
2020-'21



INDIAN SCHOOL AL BURAIMI



MR. SHAHEEN.K.K
President, SMC

S M C President's message

Dear Parents and students,

When I enquired about school magazine, Principal mentioned that this year we are going for class magazines, to increase the participation chances. I am happy with that idea and encouraged him to do so.

School magazine / Class magazine is always a very interesting piece of work created by our upcoming talented students.

Magazines develop the student's power of thinking and strengthen their imagination. In this way the general knowledge of the student's increases and they acquire the habit of reading and writing. School and class magazines also teach the students the value of co-operation and encourage healthy competition.

I feel that students are under tremendous pressure because of overloaded information. Television, Internet, Mobile phones, WhatsApp & Social Medias are snatching valuable time from our children. They get information but not retainable knowledge. Reading habit will widen their outlook and enrich their knowledge.

Our School magazine is not merely a souvenir. The school magazine is the face of the school and displays the personality of the school in many ways. It gives an articulate briefing of the activities and achievements of the school, thus building a bridge between the parents and the school. Since the school cannot inform about every activity that the School has been doing so we have our magazines. It includes academic and non-academic achievements of the school.

Finally I would like to say school / Class magazines will help you to develop your skills in your fields of interest so keep representing your school / class magazines and improve yourself year by year.

I wish you all a great success in this academic year and the years to come.

Shaheen.K.K
President, SMC
Indian School Al Buraimi.

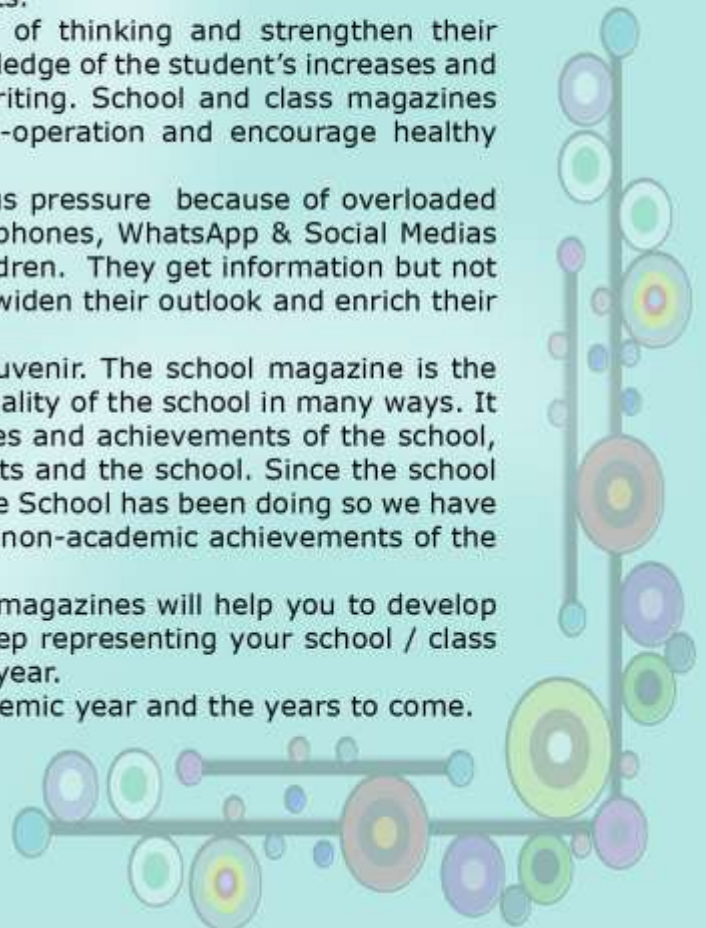



INDIAN SCHOOL AL BURAIMI



MR. SANTHA KUMAR DASARI
Principal

Principal's message

Dear students,
Warm greetings to you.

I was double minded, whether to publish the school magazine this year or not, but finally I decided to publish it because of the confidence that I have on you and my staff. Moreover this time we have gone for class wise magazines. The reason behind this move is to give wide opportunity to express yourselves in your own way. I am sure, our magazine will certainly turn into yet another piece of wonderful work form team ISAB.

When we come across difficult times, certainly we learn something new. In this COVID-19 pandemic situation we are all forced to stay, most of our time, indoors. After gone through your articles, for your class magazine, I realized that pandemics may force us to stay indoors physically but no pandemic can dent our confidence and imagination. This is one of the many things that I have learnt from this pandemic.

I found your poetic expressions, creative drawing, facts, science and maths articles, quizzes and crosswords, travelogues, investigative reports and so on are outstanding. After having gone through your articles I started envying you at your skills and thoughts. I proudly say that you are blessed with a good set of teachers, who inculcated all the skills and thought process that you showcased in your articles, you are also blessed with wonderful parents, siblings and family members who nurtured your skills carefully and supporting you whenever you are down. Of course community around you plays an important role in your behavioral patterns and thought process so I suggest you to keep a good balance of interaction with teachers, parents, siblings, near and dear and careful observation about your community to improve your all round development. I found some articles attributed to two students, I loved that concept, which is collaboration. Dear students, be positive thinkers, be problem solvers, be a part of solution, be optimistic, be critical best of all be humane.

I would like to thank each one of you, because after having gone through your articles I pushed the limits of my thought process and creativity a bit forward.

I would like to thank each and every teacher for their support and encouragement that they have given to you in accomplishing this task.

I would like to thank President Mr. Shaheen K.K and all the members of the school management committee for their continuous support in all the school related activities.

SANTHA KUMAR DASARI
Principal

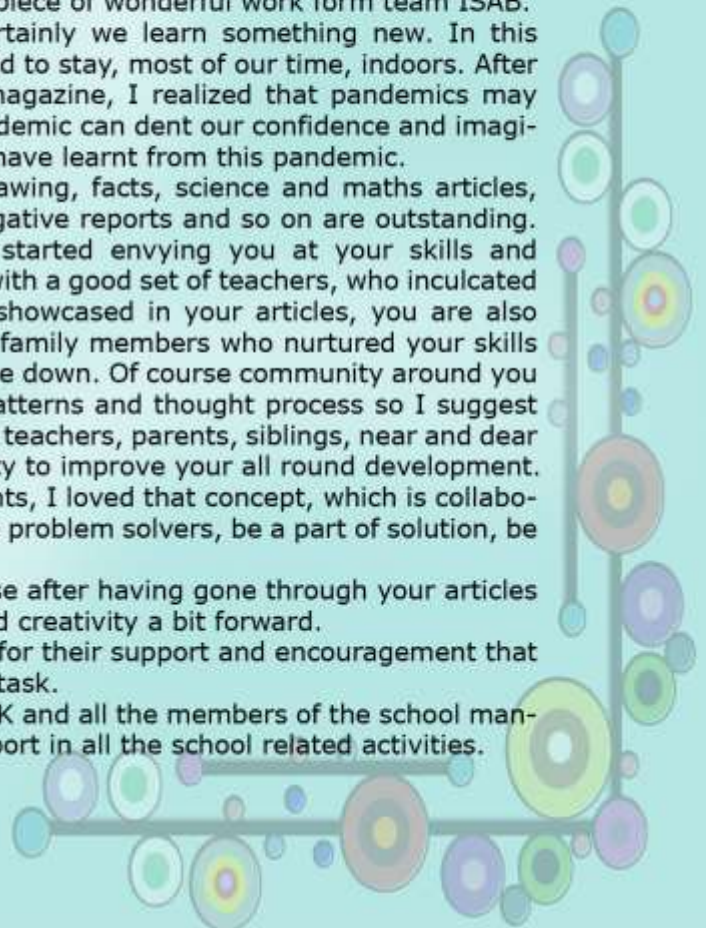



MR. JERALD PREMKUMAR
Class Teacher, Grade VI

Teacher's message

I am delighted to present our class magazine "Free wings – to fly forward" for the academic year 2020-21. I know, no one will forget this academic year, as we are in pandemic situation and we are trying to overcome the obstacles through online education. Thus, a new era begins here.

My Grade VI students have showed their interest and enthusiasm in making this e-magazine a great success. Their hard work and skills acknowledge that they are looking forward to learn and experience more in all aspects.

I pray to God and wish them a great flight so that they reach their goals with wings of knowledge and courage to overcome all the struggles in life and help the mankind for a better future.

I owe my sincere thanks to God and those who rendered their valuable suggestions and precious time for publishing this magazine.

Let's fly forward....





ROSARITA MARIA SABU
Grade VI

DREAMS



A journey of a thousand miles must begin
with a
single step
No matter where you're from
Your dreams are valid
Don't wait the time will never be just right
To accomplish great things,
We must not only act,
But also dream,
Not only plan,
But also believe
Start where you are
Use what you have
Do what you can
A heart without dreams
Is like a bird without feathers
If you want, you're dreams come true
You have to chase them down
And make them come to you
If you have a heartbeat
There is still time for you're dreams



SAJA HASSAN
Grade VI

DRAWING





FAIHA SHERIN
Grade VI

BELIEVE YOURSELF....

When many hard times you're in,
The situation that you're in
Countless struggles you're in.
Believe in yourself.....

When many things you're struggling in,
The situation that is not solved,
Countless nights you didn't sleep in and
still sobbing on.
Believe in yourself....

When for things you are compelled to say
yes.
And, for so many things you must smile.
Countless days you must think you're
understandable.
Believe in yourself...

When you're understandable.
Yet, you're in hard times .
And, your struggles are not over.
Believe in yourself...

When you don't force yourself,
And, don't have a sleepless night,
Just say you're great and think you're
yourself,
Believe in yourself...

When you think you are great
And, you're valuable and smart
I would say from my Shibboleth.
Believe in yourself..... You're great!





SAJA HASSAN
Grade VI

The clock struck 7a.m , it was almost time for school. George jumped up from the bed and got ready in no time. It was his first day of school. He was really excited to go. His mother, Sally had arranged everything a little early. George's father, Peter who was a scientist, had to work on his science experiments.

George was waiting for the school bus. Within a few minutes the bus arrived. George got into the bus. After travelling some distance , George finally glimpsed at the huge school building .He was excited. He jumped out of the bus and ran in search of his classroom.

George found his classroom in no time. There were two sections. 6 A and 6 B. There were special instructions written on the wall next to the B section door. He remembered the moment when his mother had asked him to read the instructions before entering the classroom. He read the instruction carefully. There was written, Do not enter this class.



THE MASTER OF FIVE SHADOWS

But he thought for a second." I wonder what would happen if I enter the classroom? No one is going to know if I just sneak into this classroom and come back within a minute". said George.

Then he went inside the classroom quietly. By the time he got into the room, the door closed automatically. He thought it was just wind. He was very brave and was ready to face any danger. Suddenly, he saw black dust on the handle of the door. He kept thinking about the black dust. Just then five shadows appeared in front of him . They bowed down and introduced themselves one by one.

"I am the shadow of knowledge". said the first shadow.

"I am the shadow of bravery". said the second shadow.

"I am the shadow of Honesty ". said the third shadow.

"I am the shadow of magic". said the fourth shadow.

"And I am the creator shadow. The one who created all the other shadows". said the fifth shadow.

"Okay I understand but why did you lock me in here"?asked George.

The shadow of bravery said, "You were very brave while coming to this class room".

THE MASTER OF FIVE SHADOWS

Then the shadow of knowledge said, "Nobody was this brave".

The creator shadow said, "You are the chosen one to be our master".

"What? But I am new in this school and don't know anything about here. And I am not sure that I can trust you". said George.

"You can truly trust us" said the shadow of Honesty.

"But how"? Replied George.

"By helping you". said the shadow of magic by giving him a magic pencil and an apple.

"But why are you helping me? I thought shadow creatures are all evil."

But it doesn't mean that all the shadows are evil. Some are good too. Just like us. Replied the shadow of magic.

"So what am I supposed to do with this"? said George.

"If you want something which is very important at that moment, then you can use the magic pencil to draw. So the thing you want will magically appear wherever you wish, said the shadow". "Okay. So, what about the apple"? asked George.

The shadow said, "If you eat the apple you'll feel tired and you'll sleep. So you can go back in time. "Wow that's incredible"

"So are you willing to be our master"? said the shadow of knowledge. "I'll think about it" replied George by leaving the classroom.

The next day, he came back to the classroom and explained all the amazing things happened last night with the magic apple and the pencil.



He said that he used the pencil to draw so many things to decorate his room so that his mother would be happy and he ate the apple to go back in time to fix all the mistakes that he had done in the past. "Are you willing to be our master now"? Asked the shadow of knowledge again. "Yes, but what about my friends and my family"? said George.

Then the creator shadow said, "We live in the underground world. In our world one year is like one second in your world. You can go back to your world whenever you want. George agreed and he went with the shadows to the underground world. He thought that underground world is very dark and devilish. When he reached there it was nothing like what he imagined. It was the most beautiful place that he had never seen before. It was like his dream come true! The place was very magical. He loved the place so much. And just like the shadows said, after each year, he would go back to his world and stay there for a night and at morning he will go back to school, study and go to the underground world.



DEVANANDH K.G
Grade VI

DRAWING





SUDI KSHA BALASUBRAMANIAN
Grade VI

NEELAKURINJI



Have you heard of the magical blue flowers 'NEELA KURINJI'? The plant is named after the Famous Kunthi River which flows through Kerala's Silent Valley National Park, where the plant occurs abundantly. The beauty of these mysterious flowers add extra picturesque quality to the hills of Munnar.

The Nilgiri hills turn blue once in 12 years when these flowers bloom together.

- Scientific and common name -Strobilanthes kunthiana.
- Status- Rare, endemic
- Next flowering season- 2030
- Reason-The blossom takes twelve years as the pollination for the Neelakurinji flowers need such longer period. In Botany, this is referred to as 'survival mechanism' of plants.

Longer pollination helps the species to escape total destruction by predators or even due to climate changes. So, there is a chance that annual pollination might increase the biological threat to the species, and thus it takes such an extended period to bloom.

SOME INTERESTING FACTS:

- There are almost 250 different Kurinji species in the world.
- The word 'Neelakurinji' means 'blue flower' in Malayalam language.
- Nilgiri Mountains got its name from the Neelakurinji flowers; Nilgiri: Blue Mountain.
- The name Neelakurinji is believed to be inspired from the Kunthi River.
- Tamil Nadu's 'Paliyan' tribe used the Neelakurinji flowers to calculate age.
- During the Neelakurinji blooming season, costs of honey reaches the maximum as nectars collected during this season is believed to be supreme in taste and nutrition aspects.





SUNAND DORAI S.S
Grade VI

PROMISE...

Read, but write more;
Talk, but think more;
Pray, but study more;
I promise, you will
succeed sure.
Eat, but chew more;
Weep, but laugh more;
Sleep, but walk more;
I promise you will be
healthy sure.
Hate, but love more;
Order, but obey more;
I promise people will
love you sure.
Punish, but forgive
more;
Spend, but save more;
Consume, but give
more;
I promise people will
respect you sure.





VAIGA V.SUNU
Grade VI

DRAWING





YEDU KRISHNA
Grade VI

THE GOLDEN DAYS

Reclining isolated in my couch,
Reflecting upon these ongoing days.
I never wanted these threatening days,
To play a part in my tranquil life.
I had desired for all the days to turn
into holidays,
For I wanted to have fun all day long.
Just fun and only fun.....
Now, when my wish is fulfilled,
I don't know what to do next.

My life has turned out to be a night-
mare.
Neither do I have any companions to
have fun,
Nor any cousins to get into mischief.
Neither I can go out and play,
Nor I could go out for shopping.
This is not what I wished for.
No this isn't!

I still remember those days.
When I used to go to school,
Get into mischief with my classmates,
And, had teachers to guide me through
What a wonderful days were though!
When I could walk in bustling streets,
With a smile on my face.

But I still have the hope...
The hope of a better tomorrow...
A tomorrow where we can again go
into...
Into the old and golden days.
And that is my only wish today.





MARIYAM HIBA
Grade VI

DRAWING





AIN FATHIMA
Grade VI

TRUST

TRUST EVERY SECONDS,
TRUST EVERY MINUTES,
TRUST EVERY HOUR,
TRUST EVERY TIMING.

TRUST EVERY DAY,
TRUST EVERY WEEK,
TRUST EVERY MONTH,
TRUST EVERY YEAR.

TRUST YOUR PARENTS,
TRUST YOUR SIBLINGS,
TRUST YOUR FRIENDS,
TRUST YOUR RELATIVES.

"TRUST YOUR LIFE"





DEVANANDH K.G
Grade VI

പഴയൊല്ല്

- # ഇല ചെന്നു മുളളിൽ വീണാലും മുളള് ചെന്ന് ഇലയിൽ വീണാലും കേടു ഇലക്ക് ആണ്!
- #ഇലനക്കി നായയുടെ ചിറി നക്കി നായ്!
- #ഇരുന്നിട്ട് വേണം കാല് നീട്ടാൻ!
- #ഇനാനാപേച്ചിക്കു കുട്ട് മരപെട്ടി!
- #ഉപ്പിനോളം വരുമോ ഉപ്പിലിട്ടത്!
- #ഉണ്ണിയെ കണ്ടാൽ അറിയാം ഊരിലെ പത്തം!
- #ഉരൽ ചെന്ന് മദുളത്തോട് പരാതി പറയുന്നു!
- #എരിതീയിൽ എണ്ണ ഒഴിക്കുന്നു!
- # ഒത്തുപിടിച്ചാൽ മലയും പോരും!
- # എത്തിനോക്കുന്നവാന്റെ പുറത്തു ഏണി വച്ചു നോക്കരുത്!



SAIMA
Grade VI

DRAWING

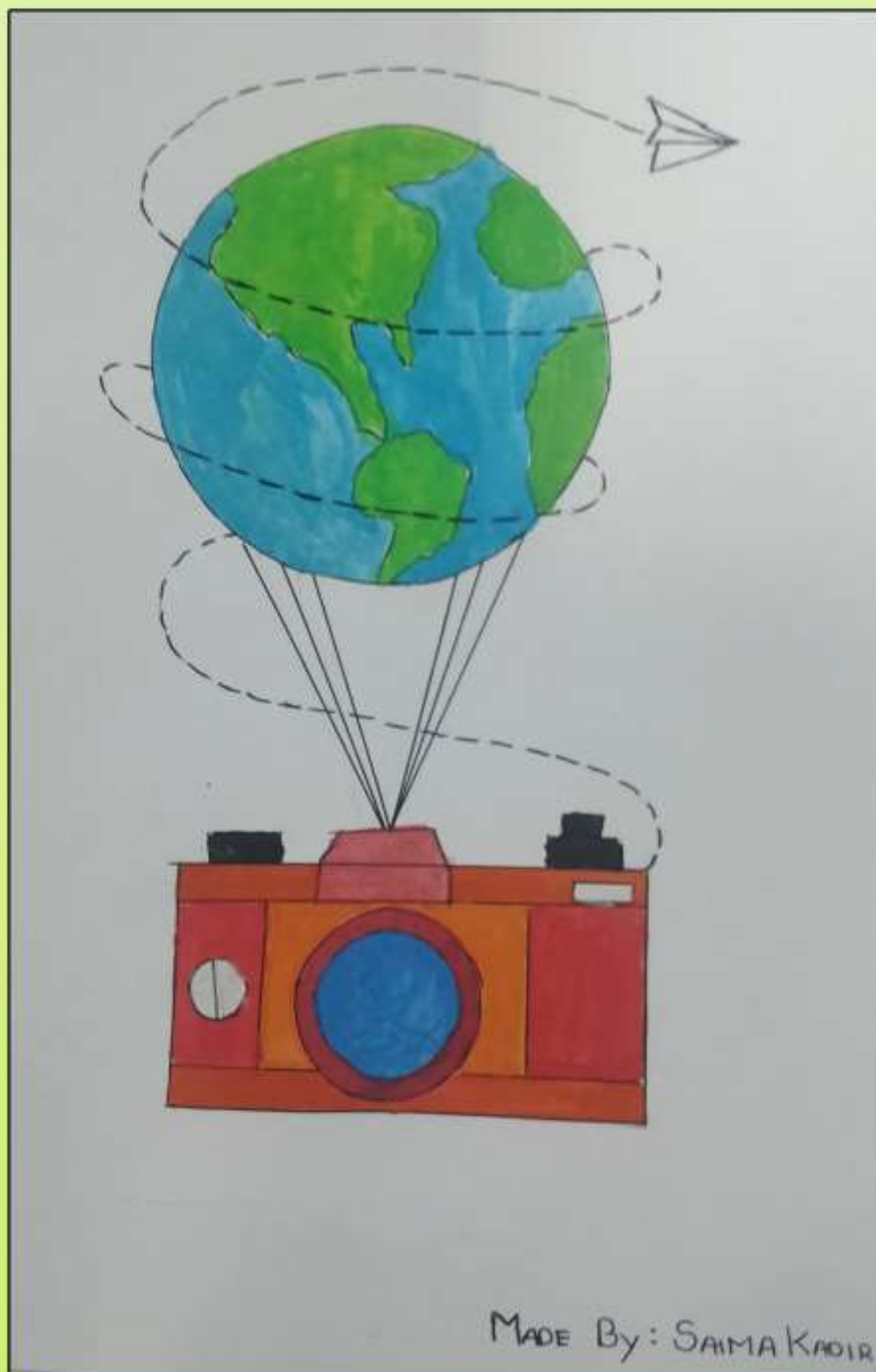



HAMAD
Grade VI

PLANTING TREE & IT'S IMPORTANCE



We all have seen in the recent times, the frequency of climate change, shooting up of temperature globally and the floods & landslides occurring in most places. In order to prevent all these we need to give importance to planting trees.

Trees play a huge role in our lives. It gives us clean air to breathe. We all know trees absorb carbon dioxide and produce oxygen which is necessary for all life to sustain. Apart from this, leaves absorb the heat which results in cooling the atmosphere.

Trees always reduce the effects of flooding. It reduces the amount of storm water runoff by reducing the pollution in water bodies. Recently, we have seen heavy landside in

Kerala and reports of many deaths. Lack of trees are resulting to exposed slopes and reducing the water in soil. This triggers the landslide easily. Tree's deep and strong roots bind the soil and surely it would prevent the landslides. Planting a tree always gives us environmental benefits. Some simple examples are the purification of air, natural cooling, preventing water pollution, reinforcing the soil. Natural cooling also gives us a stress free life and improves health. Therefore, it is responsibility of every citizen to protect & make a healthy environment and we should take a self-oath that we will plant at least one tree or more every year.



SHARON
Grade VI

DRAWING

ATOMIC MEGALEDON





MARIYAM HIBA
Grade VI

POLLUTION

Pollution is a term which even kids are aware of these days. It has become so common that almost everyone acknowledges the fact that pollution is rising continuously. The term 'pollution' means the manifestation of any unsolicited foreign substance in something. When we talk about pollution on earth, we refer to the contamination that is happening of the natural resources by various pollutants. All this is mainly caused by human activities which harm the environment in ways more than one. Therefore, an urgent need has arisen to tackle this issue straightaway. That is to say, pollution is damaging our earth severely and we need to realize its effects and prevent this damage. In this essay on pollution, we will see what are the effects of pollution and how to reduce it.



Effects of Pollution

Pollution affects the quality of life more than one can imagine. It works in mysterious ways, sometimes which cannot be seen by the naked eye. However, it is very much present in the environment. For instance, you might not be able to see the natural gases present in the air, but they are still there. Similarly, the pollutants which are messing up the air and increasing the levels of carbon dioxide is very dangerous for humans. Increased level of carbon dioxide will lead to global warming. Further, the water is polluted in the name of industrial development, religious practices and more will cause a shortage of drinking water. Without water, human life is not possible. Moreover, the way waste is dumped on the land eventually ends up in the soil and turns toxic. If land pollution keeps on happening at this rate, we won't have fertile soil to grow our crops on. Therefore, serious measures must be taken to reduce pollution to the core.



SUKHREEN KAUR
Grade VI

MY FAMILY

My family is important thing for me
Supports me and helps me a lot
Taking care of me so much
My family means for me a gift from
God
Thank you so much for support and
help
God bless my family and stay with
me for long!!

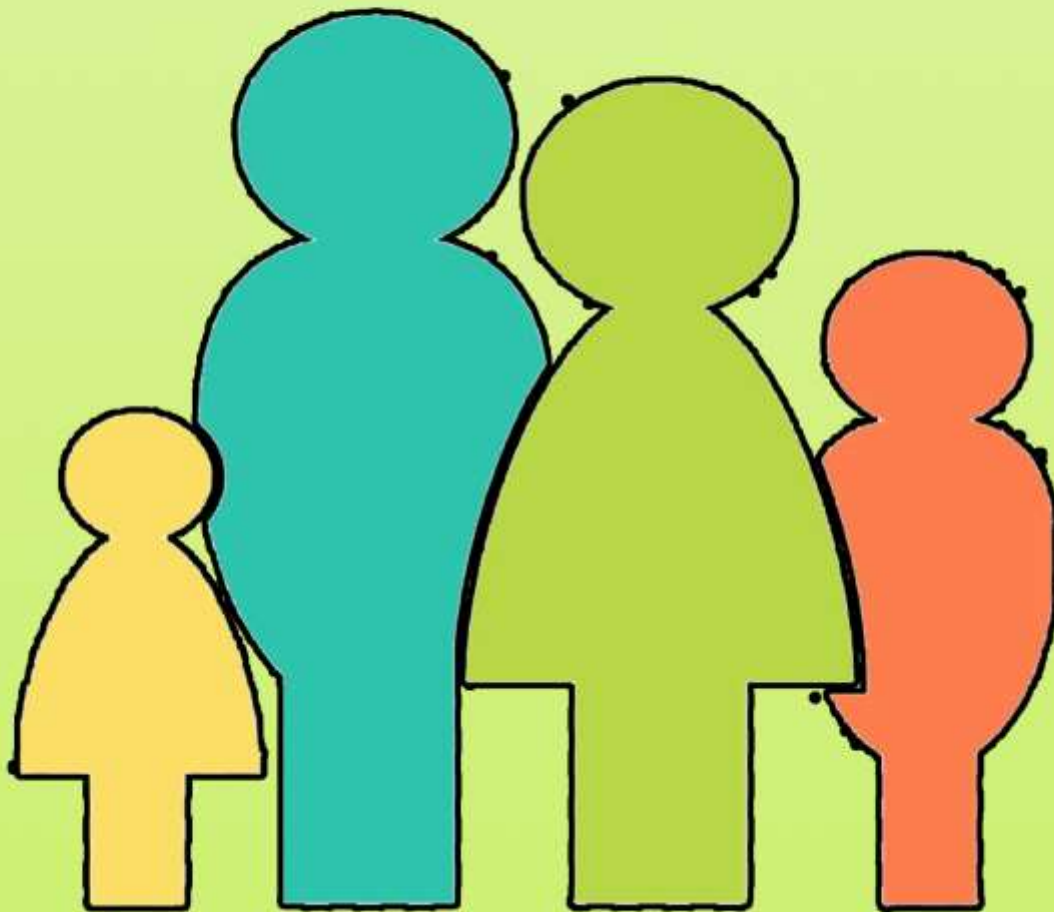



VAIGA V.SUNU
Grade VI

DRAWING





SUNAND DORAI S.S
Grade VI

COLOURS

The sun above is bright
and yellow,
We should always be a
nice fellow.

Roses are so pretty and
red.

We should always go
timely on bed.

Green are the grasses,
green are the trees,
We should always be
tension free.

Oceans and seas are
deep and blue,
We should always be
honest and true.





SAIMA
Grade VI

DRAWING





YEDU KRISHNA
Grade VI

GAME TIME!

1. He is an Indian politician, writer and a former International diplomat and is currently serving as the Member of the Parliament.

He had received the Sahitya Academy Award for his book 'An Era of Darkness' in a non-fiction category in English language. Identify this great personality.



2. He is an Indian civil engineer and a retired IRSE officer popularly known as the "Metro Man". He is credited for changing the face of public transport in India with his leadership in building the Konkan Railway and the Delhi Metro.

Identify this popular figure.



3. She was an Indian writer and mental calculator, popularly known as the "Human Computer". She strove to simplify numerical calculations for students. Her talent earned her a place in the 1982 edition of The Guinness Book of World Records.

Identify this famous mathematician



4. She was an Indian Carnatic singer from Madurai, Tamil Nadu. She was the first musician ever to be awarded the Bharat Ratna, India's highest civilian honor and also the first Indian musician to receive the Ramon Magsaysay award, often considered Asia's Nobel Prize, in 1974.

Identify this famous singer



5. There was once a time when India dominated the international hockey circuit and this man was at the center of all these triumphs. He helped India win three Olympic gold medals in 1928, 1932 and 1936.

Identify this famous player nicknamed as the Wizard of Hockey.



1. Dr. Shashi Tharoor 2. E. Sreedharan 3. Shakuntala Devi
4. Madurai Shanmukhavadivu Subbulakshmi 5. Major Dhyan Chand



ABINANDH.M.NAIR
Grade VI

ABOUT MAHATMA GANDHI

MAHATMA GANDHI WAS BORN ON 2nd OCTOBER 1869.MAHATMA GANDHIJI WAS ALSO CALLED AS-BAPUJI.HE WAS AN INDIAN LAWYER,POLITICAL LEADER ETC... HE HAD STARTED THE NATIONALIST MOVEMENT AGAINST THE BRITISH RULE IN INDIA. MAHATMA GANDHIJI DIED ON JANUARY 30,1948 IN DELHI.

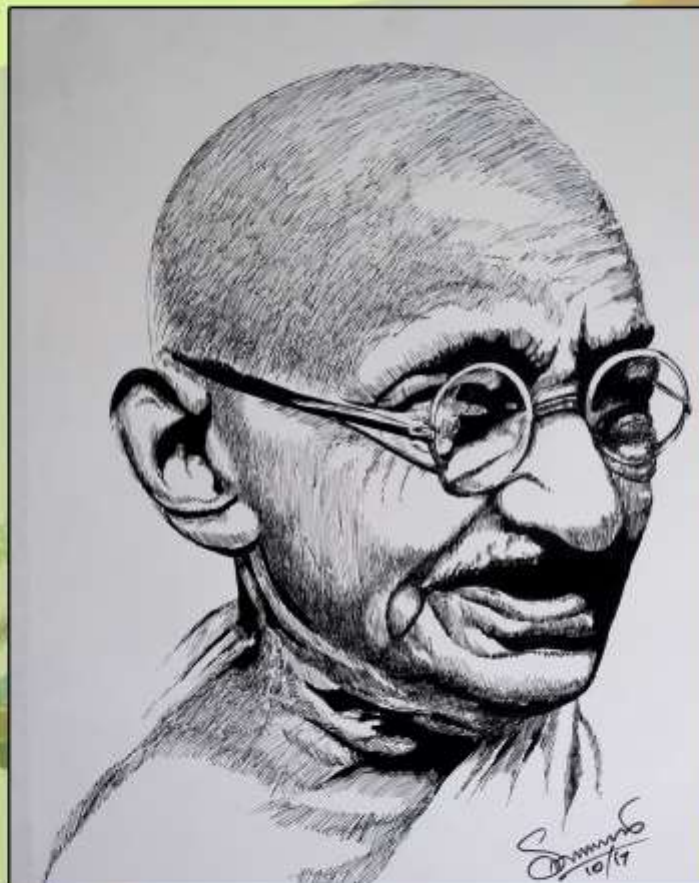

MIND BLOW MEDIA FACTS

- 1.The Earth consist of 70% Of Water.
- 2.The temperature of the Earth is 7,500 kelvin.
- 3.There are 125 billion Galaxies.
- 4.The Earth is known as Blue Planet.
5. Giza is one of the largest ancient Pyramids that mostly intact.
- 6.Scientist have discovered that the Therpod is a group of Dinosaur which include T-REX.
- 7.Scotland has 421 Words For Snow.
- 8.Armadillo Shell Are Bulletproof.
- 9.Octopus Lay 56,000 eggs at a time.
- 10.Disney characters wear gloves to keep animation simple.
- 11.There was active volcanoes on the Moon when dinosaurs were alive.
- 12.VERMONT is only one US city without a McDonald's shop.
- 13.Bumblebees can fly higher than Mount Everest.
- 14.The terminator script was sold out for \$1by James Cameron.
- 15.Pencillin was first called 'Mold Juice'
- 16.Albert Einstein's eyeballs are stored in a safe deposit box in New York.
- 17.A Stick is the world's oldest toy.
- 18.The British Empire was largest empire in the world history.
- 19.A waffle iron inspired one of the first pair of Nike.
- 20.The first University in the world was founded in India-Nalanda.



FATHIMA ZARA
Grade VI

DRAWING





YEDU KRISHNA
Grade VI

UNSCRAMBLE THE WORDS

Unscramble these letters to form meaningful words. Their meanings are given beside as clues.

1. UCATEVEA-To empty out
2. TYISORPENP-Tendency
3. UDEXERT-To expel
4. REGRATSNAHP-A passenger who stands in the train, bus, etc.
5. OIRARETEDTE-To become worse
6. TEASDSTAF-Constant firm
7. TECAXILEP-To explain or to interpret
8. SSLEPREE-Unequaled, matchless
9. UPSURM-Noisy, quarrel
10. LATOPR-Doorway, gateway

ANSWERS

1. EVACUATE
2. PROPENSITY
3. EXTRUDE
4. STRAPHANGER
5. DETERIORATE
6. STEADFAST
7. EXPLICATE
8. PEERLESS
9. RUMPUS
10. PORTAL



SHARON
Grade VI

DRAWING

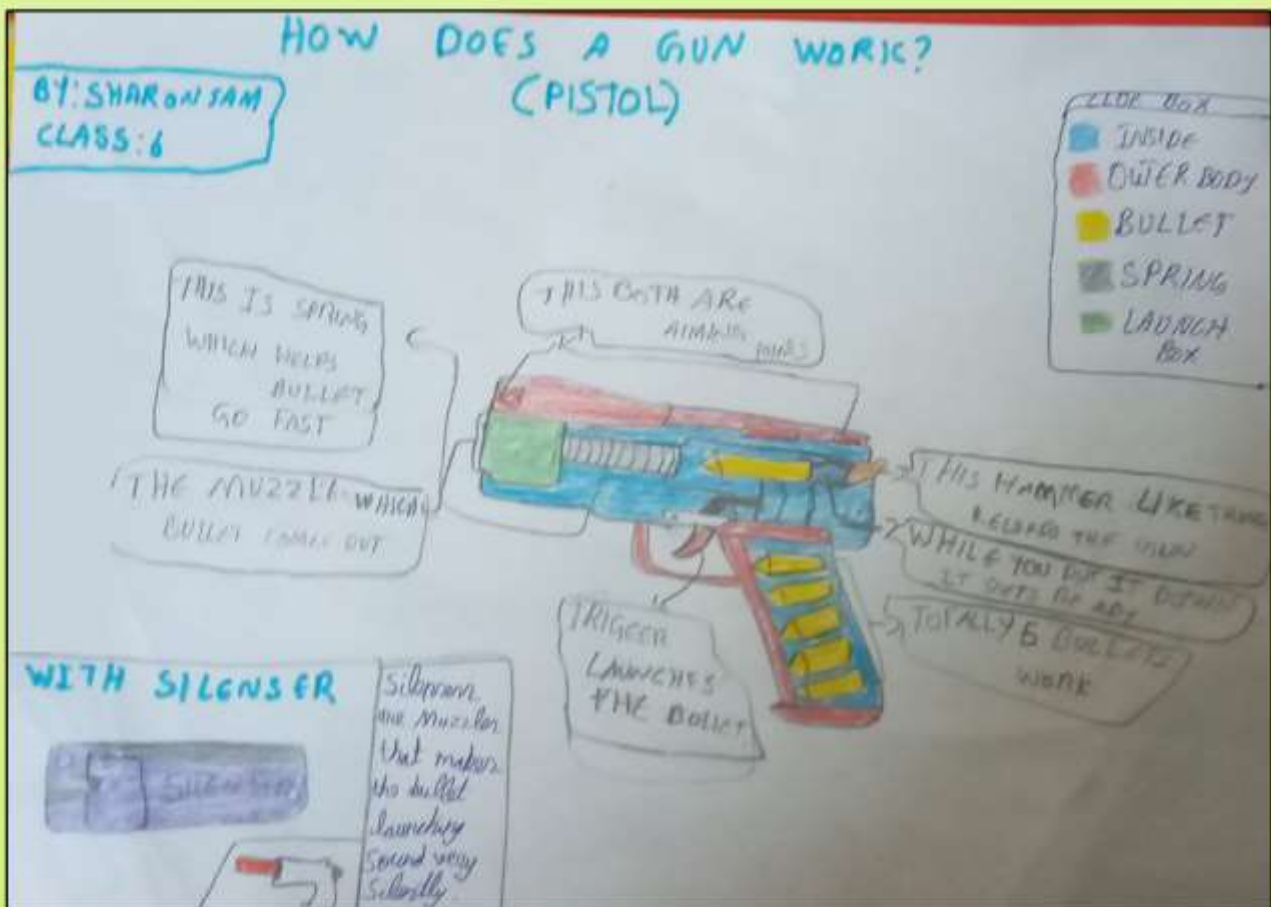



AABAN SALMAN
Grade VI

DRAWING





ROSARITA MARIA
Grade VI

FACTS

1. France covers more time zones than any country on the planet
2. Russia is bigger than Pluto.
3. Golf is the only sport to be played on Moon
4. The sport of badminton was initially called "Poona"
5. Mars had a thicker atmosphere in the past
6. The largest volcano in the Solar System is on Mars.
7. 2,520 is the smallest number that can be exactly divided by all the numbers 1 to 10
8. Any two OPPOSITE sides of a dice, when ADDED make '7'

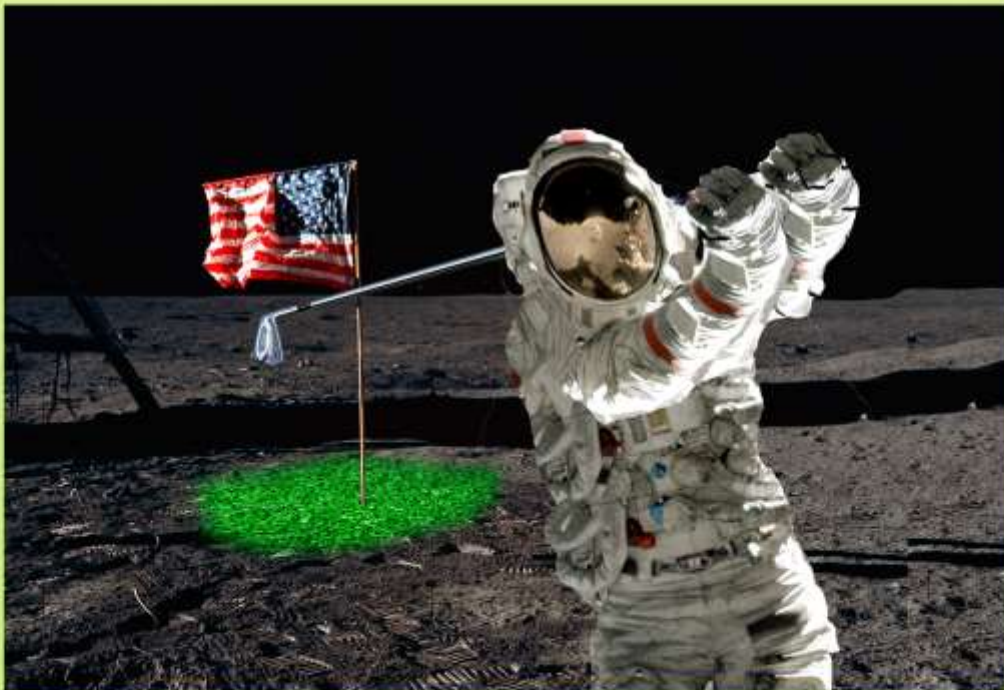



OLIUR RAHMAN
Grade VI

ELECTRIC CIRCUITS

Electricity needs a path to flow from the positive terminal to the negative terminal of a cell. An electric circuit is a closed path through which electric current can flow.

Electric devices are usually connected in a circuit. The circuit can either be a series circuit or parallel circuit.

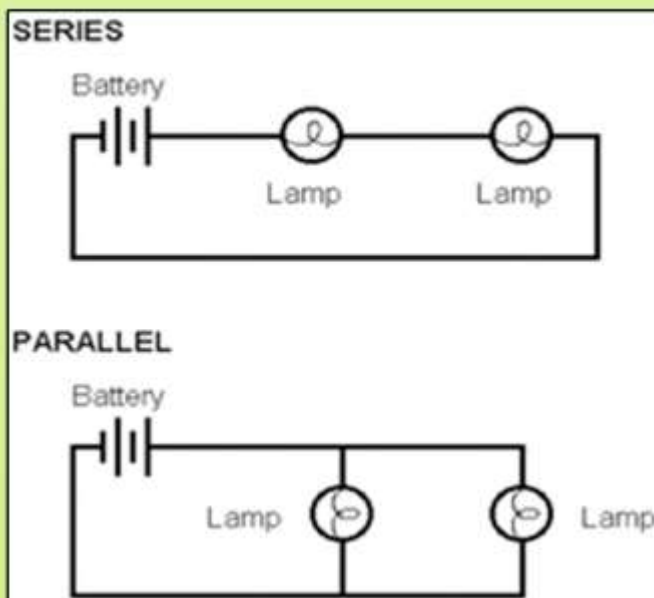

In Series circuit:

- * All the devices work instantly when the switch is turned on.

- * If one device stops working, all others stop working too.

In parallel circuit:

- * Any device can be switched on or off, without affecting the working of other devices.

- * If one device stops working, all other devices continue to work.



VARHSA BIJU
Grade VI

OUTER SPACE

Space, or simply space, is the expanse that exists beyond Earth and between celestial bodies. Outer space is not completely empty—it is a hard vacuum containing a low density of particles, predominantly a plasma of hydrogen and helium, as well as electromagnetic radiation, magnetic fields, neutrinos, dust, and cosmic rays. The baseline temperature of outer space, as set by the background radiation from the Big Bang, is 2.7 kelvins ($-270.45\text{ }^{\circ}\text{C}$; $-454.81\text{ }^{\circ}\text{F}$). The plasma between galaxies accounts for about half of the baryonic (ordinary) matter in the universe; it has a number density of less than one hydrogen atom per cubic meter and a temperature of millions of kelvins. Local concentrations of matter have condensed into stars and galaxies. Studies indicate that 90% of the mass in most galaxies is in an unknown form, called dark matter, which interacts with other matter through gravitational but not electromagnetic forces. Observations suggest that the majority of the mass-energy in the observable universe is dark energy, a type of vacuum energy that is poorly understood. Intergalactic space takes up most of the volume of the universe, but even galaxies and star systems consist almost entirely of empty space.

